

700 EASY



Characteristics



- A Refrigeration unit**
Sparblock plug-in - monobloc ventilated system
- E Insulation thickness**
60mm - HFO polyurethane (no CFC, no HCFC)
- F Internal finish**
AISI 304 stainless steel
- J Floor support**
Stainless steel feet, galvanised external bottom panel
- K Rounded corners/removable parts**
For easy cleaning
- O Worktop**
AISI 304

- Q Interchangeable doors and drawers**

Technical drawing and set-up

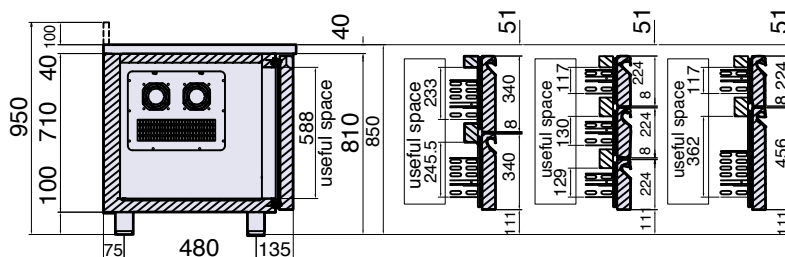
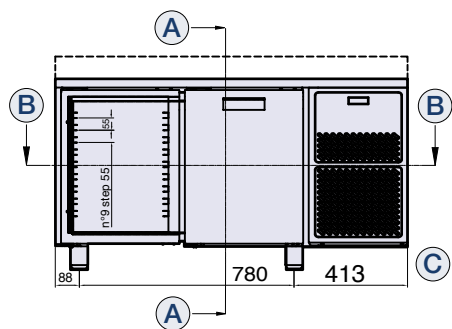

A-A

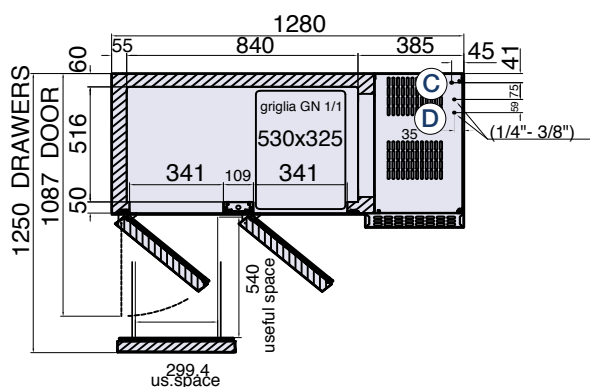





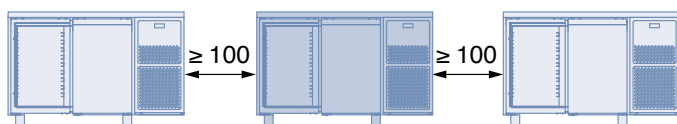







B-B

- A Section plane**
- B Section plane**
- C Power cable outlet (length 2 m)**
WARNING! While installing, have a qualified electrician connect it to an electrical panel.
- D Gas pipes outlet**
Prepared for remote motor



Technical specifications

Temperature (°C)	 0/+10	 -18/-22	 0/+10	 -18/-22
Model	PECT702XX	PECT702BTXX	PECT702MRXX	PECT702BTMRXX
Doors				
Dimensions (mm) L x D x H	1280 x 700 x 850-900	1280 x 700 x 850-900	1280 x 700 x 850-900	1280 x 700 x 850-900
Packaging (mm) L x D x H	1320 x 730 x 1100	1320 x 730 x 1100	1320 x 730 x 1100	1320 x 730 x 1100
Refrigerant	 R134a	 R507 (R404a)	 R134a	 R507 (R404a)
Absorption (W)	318	670/600	30	90/600
Voltage (V-Hz)	230-1 50/60Hz	230-1 50Hz 230-1 60Hz	230-1 50/60Hz	230-1 50/60Hz
Net weight (kg)	93	96	79	82
Gross weight (kg)	106	109	92	95

