

# 700 EASY



## Caractéristiques



### A Unité de réfrigération

Sparblock plug-in - système ventilé monobloc

### E Épaisseur d'isolation

60 mm - polyuréthane HFO (sans CFC ni HCFC)

### F Finition interne

Acier inox AISI 304

### J Support au plancher

Pieds en inox, fond ext. galvanisé

### K Angles arrondis/pièces amovibles

Pour faciliter l'entretien

### O Plan de travail

AISI 304

### Q Possibilité d'interchanger les portes et les tiroirs

# Dessin technique et prédispositions

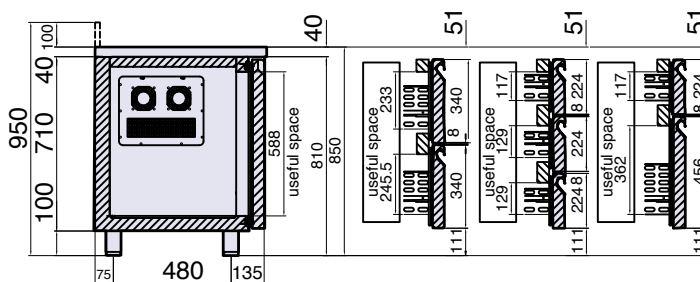
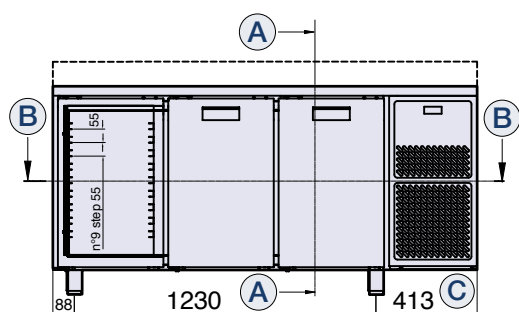

**A-A**

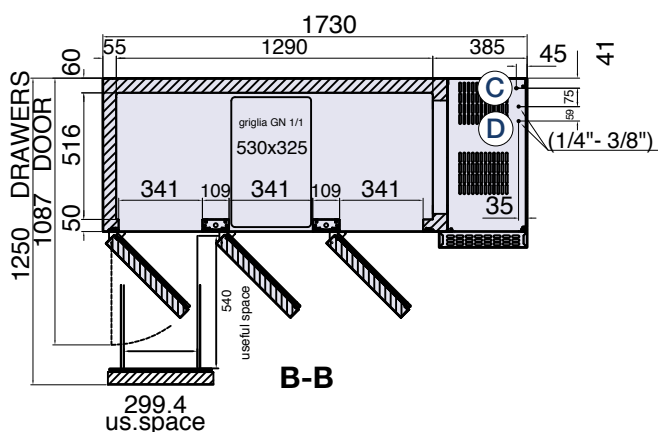





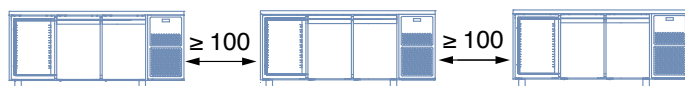







**B-B**

- A Plan de section**
- B Plan de section**
- C Sortie du cordon d'alimentation (2 m de longueur)**  
ATTENTION ! Prévoir, pour l'installation, l'intervention d'un électricien qualifié pour le branchement au tableau électrique.
- D Sortie des tubes de gaz**  
Prédisposition pour le moteur à distance



## Caractéristiques techniques

Température (°C)	 0/+10	 -18/-22	 0/+10	 -18/-22
Modèle	PECT703XX	PECT703BTXX	PECT703MRXX	PECT703BTMRXX
Portes				
Dimensions (mm) L x P x H	1730 x 700 x 850-900	1730 x 700 x 850-900	1730 x 700 x 850-900	1730 x 700 x 850-900
Emballage (mm) L x P x H	1770 x 730 x 1100	1770 x 730 x 1100	1770 x 730 x 1100	1770 x 730 x 1100
Gaz réfrigérant	 R134a	 R507 (R404a)	 R134a	 R507 (R404a)
Absorption (W)	318	670/600	30	90/600
Voltage (V-Hz)	230-1 50/60Hz	230-1 50Hz   230-1 60Hz	230-1 50/60Hz	230-1 50/60Hz
Poids net (kg)	116	119	102	105
Poids brut (kg)	132	135	118	121

